

## HSA-275/2+1 S IT

- Surge arresters type T2 ensure the equipotential bonding and reduce switching, induced and residual overvoltage in single-phase and three-phase IT power supply systems.
- The products consist of varistors with big discharge ability with gas discharge tube, which ensures zero leakage current in the PE conductor.
- Installed at the boundaries of zones LPZ 1 – LPZ 2 into subsidiary switchboards and control panels.
- **S** indication specifies a version with remote monitoring.

Type		HSA-275/2+1 S IT
Test class according to EN 61643-11:2012 (IEC 61643-11:2011)		T2
System		IT
Number of poles		3
Nominal line voltage	$U_N$	230 V
Maximum continuous operating voltage AC	$U_C$	275 V
Maximum discharge current (8/20) L/CP	$I_{max}$	50 kA
Nominal discharge current for class II test (8/20) L/CP	$I_n$	20 kA
Open circuit voltage of the combination wave generator	$U_{OC}$	6 kV
Total discharge current (8/20) L1+L2+CP->PE	$I_{Total}$	50 kA
Voltage protection level at $I_n$ (CP/PE)	$U_p$	< 1.5 kV
Voltage protection level at $I_n$ (L/CP)	$U_p$	< 1.2 kV
Voltage protection level at $U_{OC}$ (L/CP)	$U_p$	< 0.8 kV
Temporary overvoltage test (TOV) for $t_T = 5$ s (L/CP)	$U_T$	337 V
Temporary overvoltage test (TOV) for $t_T = 0.2$ s (L/PE)	$U_T$	1 455 V
Response time (L/CP)	$t_A$	< 25 ns
Response time (CP/PE)	$t_A$	< 100 ns
Maximal back-up fuse		160 A gL/gG
Short-circuit current rating at maximum back-up fuse	$I_{SCCR}$	60 kA <sub>rms</sub>
Lightning protection zone		LPZ 1-2, LPZ 2-3
Housing material		Polyamid PA6, UL94 V-0
Degree of protection		IP20
Operating temperature	$\theta$	-40 ÷ 70 °C
Minimum cross-section of connected Cu conductors accord. to HD 60364-5-53:2022 (doesn't apply to „V“ connection) for T2	S	2.5 mm <sup>2</sup> (L, N) 6 mm <sup>2</sup> (PE, PEN)
Clamp fastening range (solid conductor)		1.5 ÷ 25 mm <sup>2</sup>
Clamp fastening range (stranded conductor)		1.5 ÷ 16 mm <sup>2</sup>
Tightening moment		3 Nm
Installation		On DIN rail 35 mm
Modular width		3 TE
Operating position		Any

Type		HSA-275/2+1 S IT
Signalling at the device		Optic
Importance of local signalling		OK – clear target FAULT – red target
Remote signalling		Yes
Potential free signal contact (S) (recommended cross-section of remote monitoring max. 1 mm <sup>2</sup> )		AC: 250 V / 1.5 A, DC: 250 V / 0.1 A
Modular design		No
Lifetime		> 100 000 h
<b>Designed according to standards</b>		
Requirements and test methods for SPDs connected to low-voltage power systems		IEC 61643-11:2011
Safety of Flammability of Plastic Materials		UL 94
<b>Application standards</b>		
Protection against lightning		IEC 62305:2010
Selection and erection of electrical equipment – Switchgear and controlgear		HD 60364-5-53:2022
Selection and application principles for SPDs connected to low-voltage power systems		CLC/TS 61643-12:2009
<b>Ordering, packaging and additional data</b>		
Mass	m	266 g
Mass (including the packaging)	m	290 g
Packaging dimensions (H x W x D)		60 x 113 x 73 mm
Packaging value	V	0.5 dm <sup>3</sup>
ETIM group		EG000021
ETIM class		EC000941
Customs tariff no.		85363010
EAN code		8590681169841
<b>Art. number</b>		<b>27 573</b>



The link in the QR code leads to the online presentation of the **HSA-275/2+1 S IT**. There, in addition to the always up-to-date data sheet, you will also find all diagrams and drawings, declarations of conformity, or 2D or 3D models and other necessary materials. For more information, visit [www.hakil.com](http://www.hakil.com)



**Application wiring diagram (installation)**

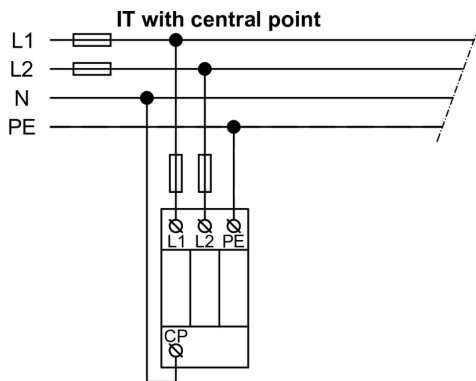

**Internal diagram**

